



WATERCOOL

Watercool HEATKILLER® Tube 100 D5

\$94.95

Product Images

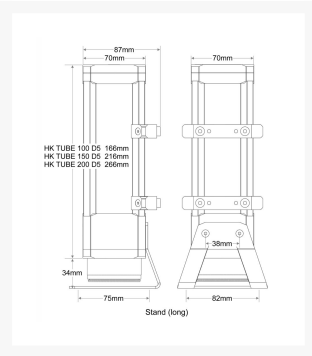

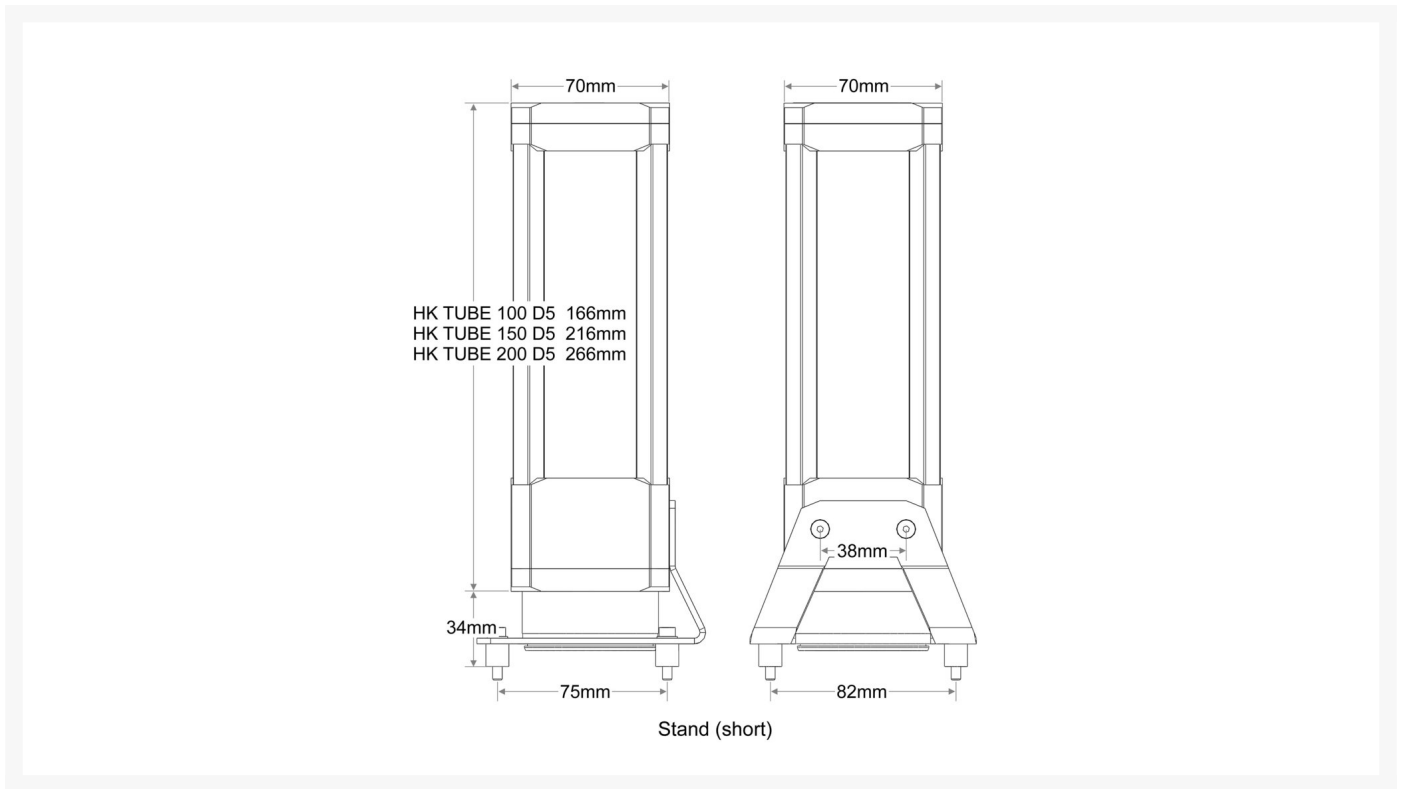

Features

Large filling mouth

Thanks to a large filling mouth and a bayonet catch lid the HEATKILLER® Tube Series reservoirs can be opened without any tools and is easy to fill. It has never been easier to re-fill a cooling medium.

Borosilicate glass tube

Borosilicate is a glass with very high chemical and thermic resistance. It is scratch-resistant and has very low heat expansion. These outstanding features make borosilicate an ideal material for reservoirs.

Three sizes

To account for different space availability in current cases, the HEATKILLER® Tube Series reservoir glass tubes are available in sizes 100mm, 150mm and 200mm.

Three versions

Besides a standalone version, there are versions with direct connections for pumps. They support D5 and DDC pumps by Lowara (formerly known as Laing) and their derivatives.

Large volume

In designing the HEATKILLER® Tube Series, we took great care not to waste any of the available volume. That makes the HEATKILLER® Tube Series reservoirs very low maintenance, because they need fewer re-fills.

Anti- Cyclone-effect

The exclusively developed anti-cyclone-inlay which is located at the bottom of the reservoir prevents vortices that easily form in reservoirs. This reduces noise levels and makes air bleeding easier.

Streaming-optimized pump chambers

The pump adapter for D5 and DDC pumps comes with a streaming optimized pump chamber. This causes fewer vortices during use, which has a positive effect on both flow rate and air bleeding.

Made in Germany

The HEATKILLER® Tube Series reservoirs are completely produced in Germany.

Extensive optional accessories

The HEATKILLER® Tube Series reservoirs have various optional features, for example:

Variable Mounting systems

For optimal integration into a water cooled system we offer different mounting systems to fit your build.

...horizontal mount (pedestal)

Two different height pedestals are available for mounting the HEATKILLER® Tube Series reservoir to the case floor or free-standing.

... vertical mount

A multifunctional bracket mount offers options for vertical montage. Several adapters are available. Some can be used to attach the reservoir to 120x120mm or 140x140mm cooler slots. Others allow for a montage of the reservoir on a radiator from the MO-RA3 series.

Illumination

HEATKILLER® Tube Series reservoirs can be set in scene with LED illumination. We offer splash-safe LED strips in various colors. The strips are hidden in the struts of the reservoir cage.

Colored struts

To customize your HEATKILLER® Tube Series you can exchange the default struts. We offer aluminum struts in natural color or with a choice of anodized colors.

Specifications

Material cover: POM

Material struts: black anodized aluminium

Tube: borosilicate glass

Material bottom: POM

Material Inlay: stainless steel

Measurements (L x W x H): 70 x 70 x 203,4 mm

Tube length: 100mm

Tube diameter: 65mm

Capacity: aprox. 250ml

Weight: aprox. 650g

Seal: NBR, VMQ

Connection thread: 2x G ¼ inch (DIN ISO 228-1)

Scope of delivery:

1x HEATKILLER® Tube 100 D5

1x manual

Additional Information

Brand	Watercool
SKU	WC-30203
Weight	1.5000
Color	Clear
Reservoir Type	Free Standing Tank
Tube Res Length	100mm

