

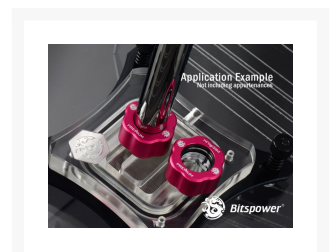

Bitspower Premium Master Hard Tube Fitting MHT14 6 Pack - Abrasive Red

\$29.75

Product Images

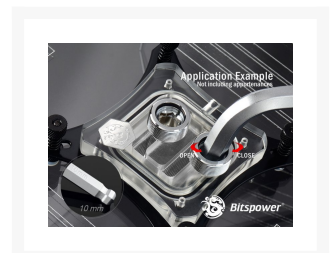

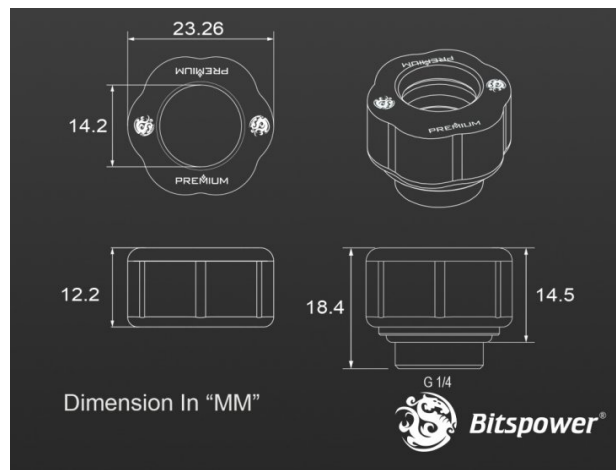

Short Description

Bitspower Premium Master Hard Tube Fitting MHT14 Are Design For Hard Tubing OD14MM. They Have A Unique Surface For Each Nut With Concentric Circles By Handmade.

Description

Bitspower Premium Master Hard Tube Fitting MHT14 Are Design For Hard Tubing OD14MM. They Have A Unique Surface For Each Nut With Concentric Circles By Handmade.

Features

1. Unique Surface For Each Nut With Concentric Circles By Handmade.
2. Labeled With Unique Number.
3. Design For Hard Tubing OD14MM.
4. Inner Hexagonal Design.
5. High Quality Brass And Aluminum (Nut)Material.
6. Brass With High Durability Nickel Finished In Silver Shining Color.
7. Aluminum With High Durability Anodizing Finished In Red Color.
8. RoHS Compliant.

Specifications

Thread : G1/4"

Thread Length : 5MM

Quantity : 6 PCS

Application Item:

BP-HEXW10-ASL

*User can use this hexagon wrench 10MM to fix these BP-PREMHT12/14/16/12IN series easily.

*****All Specification Will Be Changed Without Further Notice*****

Additional Information

Brand	Bitspower
SKU	BP-PREMHT14-ARD6P-D
Weight	1.0000
Special Order	No
Fitting Type	Rigid Compression
Fitting Size	14mm
Fitting Angle	Straight
Fitting Finish	Red
Vendor SKU/EAN	4712914776938

