



BARROW Barrow LRC2.0 full coverage GPU Water Block for MSI RTX3090 TRIO Aurora

Special Price
\$59.96 was
~~\$99.99~~

Product Images



BARROW

LRC 2.0 AURA SYNC RGB FUSION 2.0 RGB POLYCHROME SYNC

Compatible with
MSI RTX 3090 GAMING X TRIO 24G

MSI RTX 3090 GAMING X TRIO 24G
 MSI RTX 3090 GAMING TRIO 24G
 MSI RTX 3080 GAMING X TRIO 10G
 MSI RTX 3080 GAMING TRIO 10G

P/N:BS-MSG3090M-PA





Compatible with
MSI RTX 3090 GAMING X TRIO 24G

MSI RTX 3090 GAMING X TRIO 24G
MSI RTX 3090 GAMING TRIO 24G
MSI RTX 3080 GAMING X TRIO 10G
MSI RTX 3080 GAMING TRIO 10G

P/N:BS-MSG3090M-PA

Short Description

Barrow LRC2.0 full coverage GPU Water Block for MSI RTX3090 TRIO

Description

BS-MSG3090M-PA

Barrow LRC2.0 full coverage GPU Water Block for MSI RTX3090 TRIO Aurora

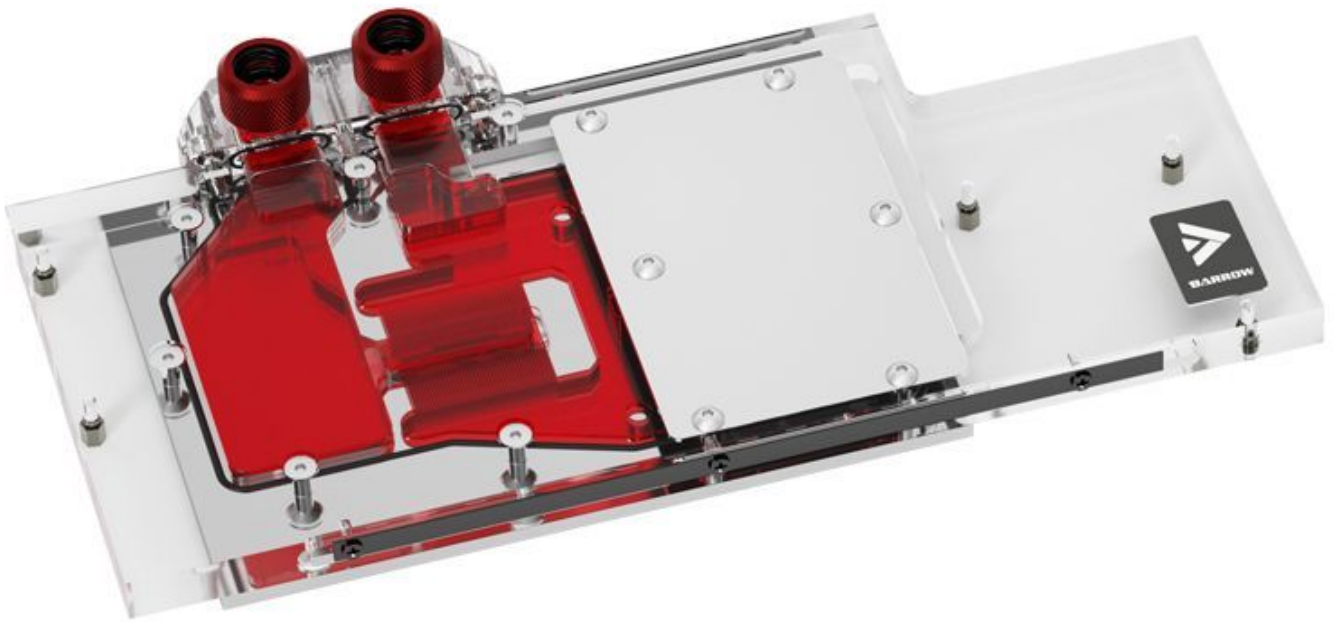

BS-MSG3090M-PA

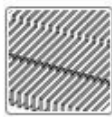

Micro water passage



Copper-nickel
plated mount



Imported acrylic



Patent Bridge

◇ Products information

Mode: BS-MSG3090M-PA	Color: Transparent
Quantity: 1Set	Thread: G1/4"
Material: Red copper+Acrylic	Dimensions: Please refer to the dimension drawing
Application: Suitable for desktop computer graphics card cooling.	
Note: In case of product appearance structure upgrade,without further notice,in kind prevail	



Original imported high-transparency acrylic board

High-temperature-resistant and high-transparency imported acrylic raw materials have higher transparency, longer life, no color change, no cracking, and emitting full of internal brilliant lighting effects.

High-density jet microchannel

The enlarged area of water passage has as many as 43 micro-channels, each with bottom-clearing slots and 5+3 (0.5MM groove width + 0.3MM interval) asymmetric water channels. The contact area between the water-cooling liquid and the soleplate is increased, as well as the heat dissipation efficiency of the cold head is enhanced.

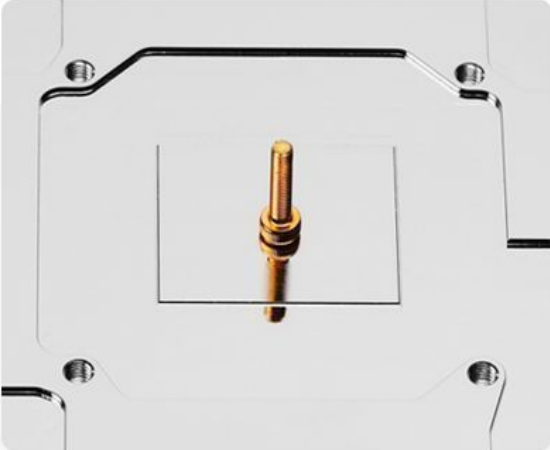
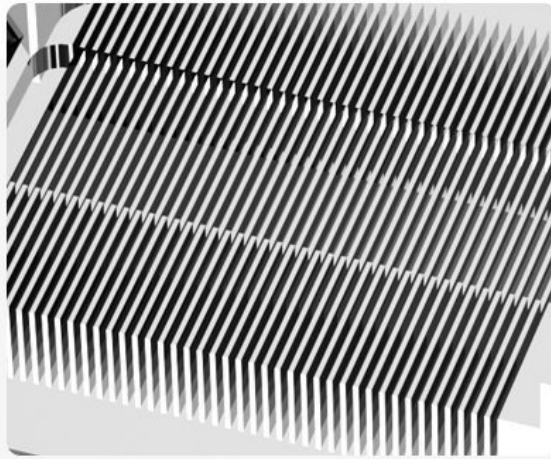

Copper-nickel plated mount

As the main material of the soleplate, copper with thermal conductivity which is less than silver, has high heat absorption and heat transfer efficiency. The surface adopts the mirror nickel plating process, which can effectively prevent the soleplate from oxidation and increase the service life.

Appearance patent bridgehead

Patent No.: 2016304260188

Unique appearance design, plus translucent logo makes the lighting effect more gorgeous.



Lighting effects show

Version 2.0 lamp belts and lamp beads can produce asynchronous static and dynamic lighting effects, that is, each lamp bead can independently change color in the same period. The built-in removable RGB light components can replace the light components according to the actual needs.

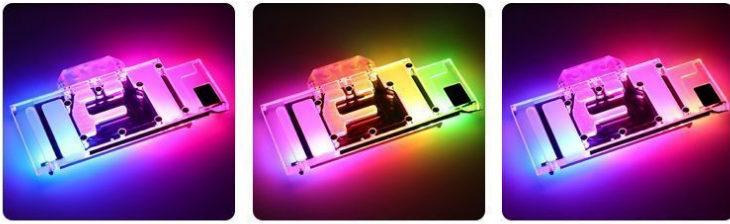

Control system 2.0

LRC full-color RGB lighting control system 2.0 includes BARROW's version 2.0 manual controller and 16 channel remote controller. It can be compatible with the RGB lighting components and other independent products as well as built-in lighting components of all BARROW's 2.0 versions.



Compatible motherboard programmable ARGB light interface

Motherboard with 5V programmable ARGB pin can be connected via adapter ZBDZJX-5



Barrow ZBDZJX-5 adapter cable



Length: 40cm

The adapter cable is not a standard accessory, please purchase separately

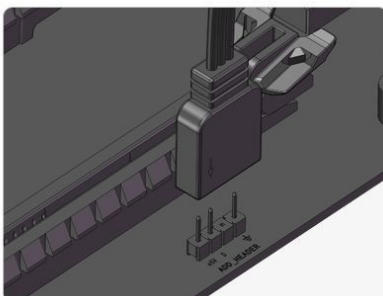
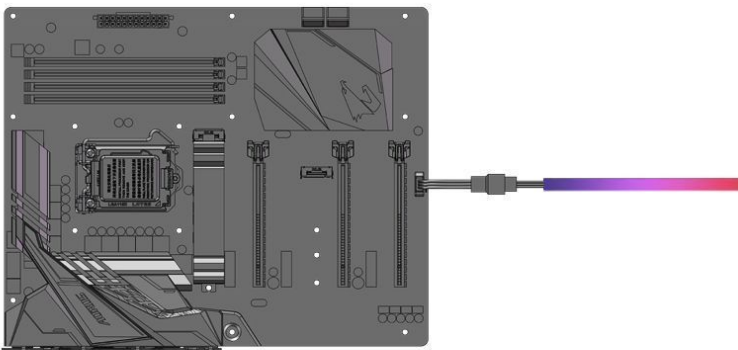

The 5V ARGB adapter cable should be connected to the corresponding motherboard interface in the corresponding direction

The ZBDZJX-5 adapter cable can only be connected to the motherboard 5V 3-pin ARGB lighting interface

Water block compatible GPU model



**MSI RTX 3090 SUPRIM X
24G**



**MSI RTX 3090 GAMING X
TRIO 24G**



**MSI RTX 3090 GAMING
TRIO 24G**



**MSI RTX 3080Ti SUPRIM X
12G**



**MSI RTX 3080Ti GAMING X
TRIO 12G**



**MSI RTX 3080 SUPRIM X
10G**



**MSI RTX 3080 GAMING X
TRIO 10G**



**MSI RTX 3080 GAMING
TRIO 10G**

Installation example

Step1: Remove the original radiator and smear silicone grease or adhesive silicone pad

Clean up the residual silicone grease and silicone grease pad, smear new heat conductive grease and silicone grease pad again

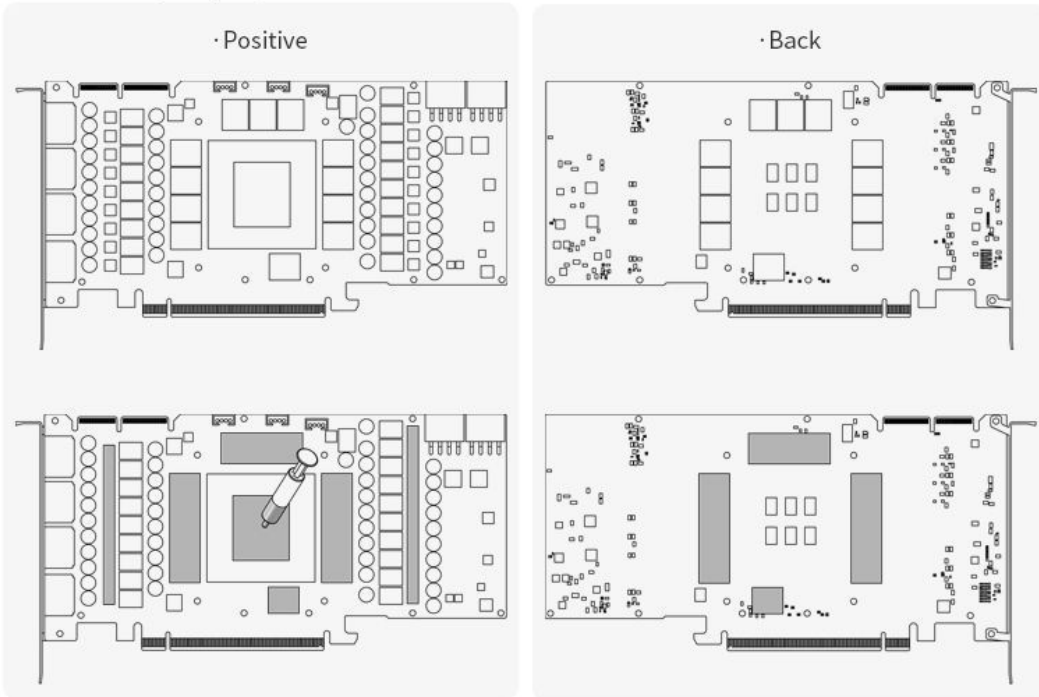

Step2: Place one side of the graphics card bottom board upwards, and place the white ABS pad on the copper column. Fix and install the graphics card and cold head screw hole to its rear locking screw.

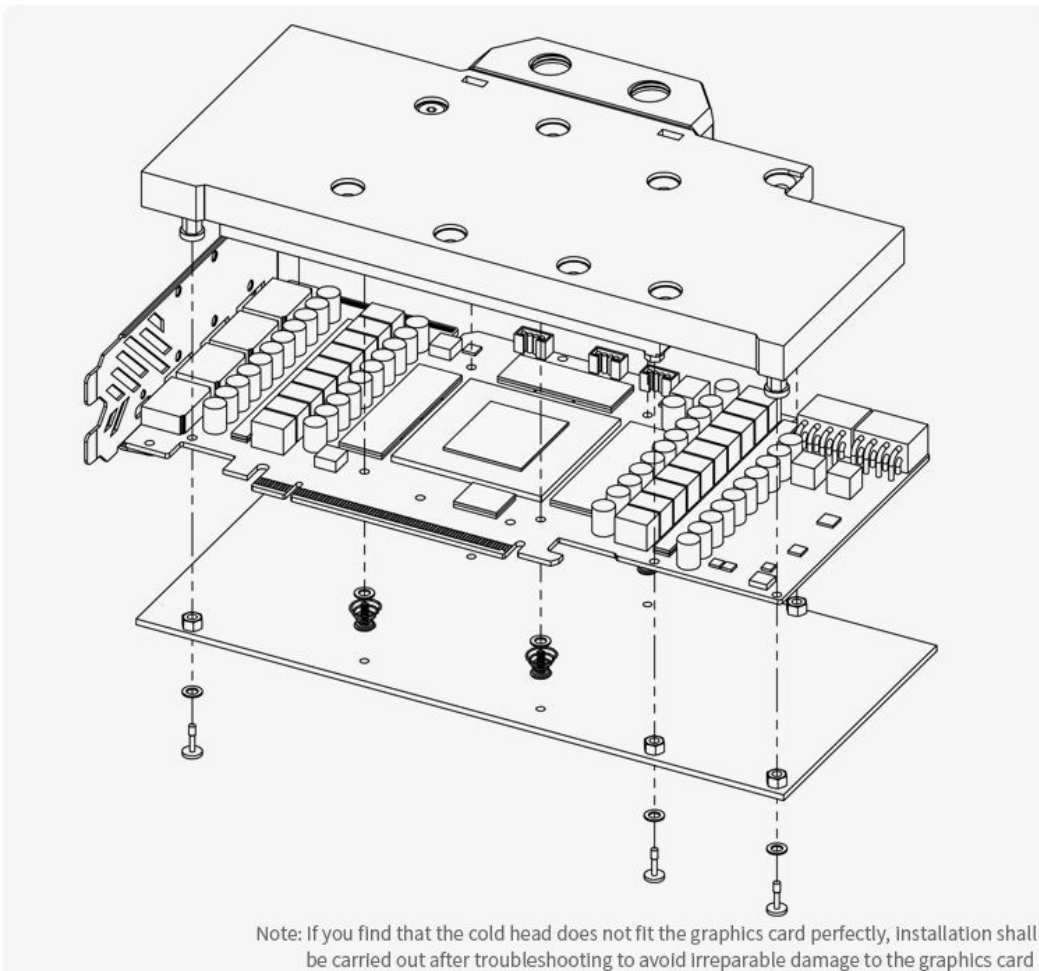

Note: If you find that the cold head does not fit the graphics card perfectly, installation shall be carried out after troubleshooting to avoid irreparable damage to the graphics card

Additional Information

Brand	Barrow
SKU	BS-MSG3090M-PA
Weight	3.0000
Color	Clear
Vga	MSI RTX 3090 Gaming Trio
Block GPU Type	Nvidia
Block Style	Copper-Nickel
Vendor SKU/EAN	0
Special Price	\$59.96

