

Bykski Full Coverage GPU Water Block and Backplate for MSI RTX 3070 GAMING X TRIO

Special Price
\$151.99 was
\$189.99

Product Images

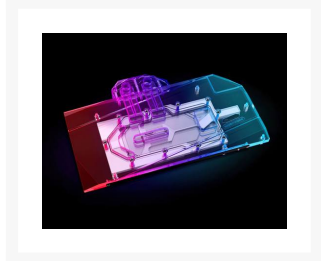

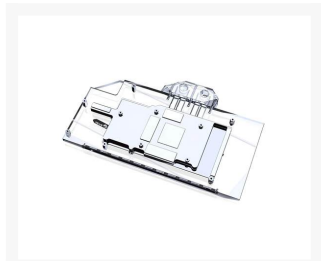
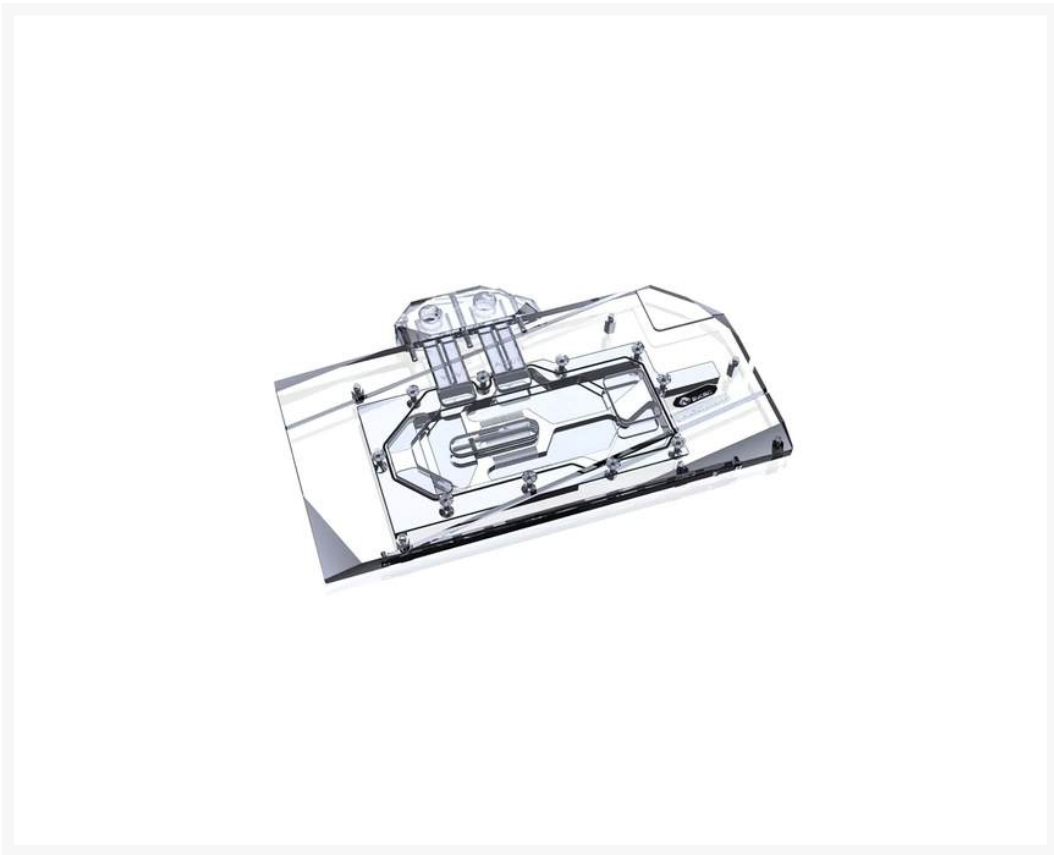

Before applying silicone grease:

Positive

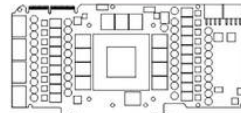

Back

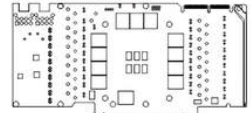

1. Clean up the residue of the original circuit and chip
2. Cut the thermal conductive glue into suitable size

After applying silicone grease:

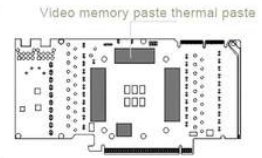
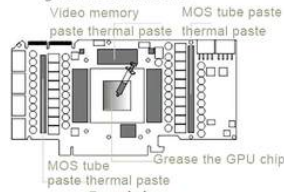

Positive

Back

1. For graphics cards without a backplane:
After attaching an insulating washer above the corresponding screw hole on the backplane, tighten it with a spring screw.

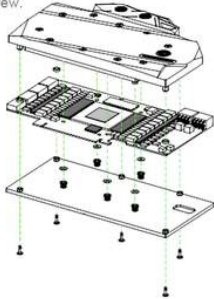

2. For the backplate and water block:
After placing the backplate on the back of the graphics card, use the backplane screws to lock the corresponding screw holes.

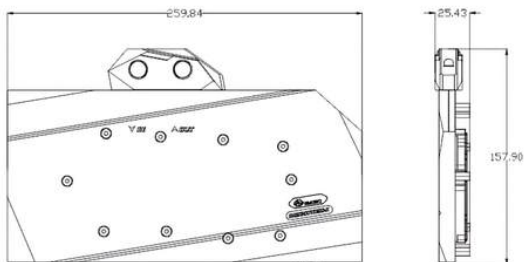
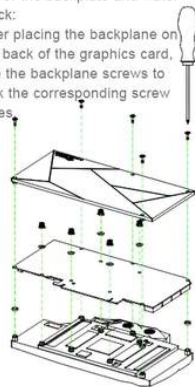

Short Description

This full coverage block directly cools the video cards core (GPU), graphics memory (RAM), and voltage

regulator modules (VRM).

Description

This full coverage block directly cools the video cards core (GPU), graphics memory (RAM), and voltage regulator modules (VRM). By directly cooling these components you can achieve great temperatures along with the ability to reach higher overlocks or extend the overall lifespan of your card by running at below factory temps.

The block is constructed of high purity copper that is electroplated to prevent oxidation. A high flow design is used to allow multiple blocks to run in series. Top and bottom ports can be used to configure parallel or serial designs in multi block set ups

Specifications

SPECIFICATIONS

- Block Material: Electroplated High Purity Copper / Acrylic
- Backplate Material: Black Anodized Aluminum (not in contact with coolant)

COMPATIBILITY

- *(Including but not limited to the following models)*
- MSI GeForce RTX 3070 GAMING TRIO
- MSI GeForce RTX 3070 GAMING X TRIO
- MSI GeForce RTX 3070 SUPRIM X 8G
- MSI GeForce RTX 3060Ti GAMING X TRIO
- Please check over the entire PCB picture after narrowing your selection to ensure compatibility. If you have any questions, please contact support for confirmation.
- *Compatibility based on these circuit board designs only*
- Fittings: G 1/4in. Thread

PARTS INCLUDED

- 1x Full Coverage GPU Water Block
- 1x Backplate
- 2x Stop Fitting
- 1x Mounting Hardware
- Thermal grease
- 1x 5v A-RGB (RBW) Light
- (Warning: Addressable RGB (RBW) is 5V and is ONLY compatible with Addressable RGB (RBW) components. RGB is 12V and is ONLY compatible with RGB components. Mix and match will NOT work and will cause damage.

WARNINGS

This is a repair or replace only item. Returns not accepted on compatibility issues or if block has had water/fluid run through it.

Manufacturer reserves right to alter block design to expand compatibility. Delivered item may not 100%

match pictured item. Product does NOT come with English instructions.

Not responsible for any damage caused by or when using this product. Please use at your own risk.

Additional Information

Brand	Bykski
SKU	N-MS3070TRIO-X
Weight	3.5000
Color	Clear
Vga	MSI RTX 3070 GAMING X TRIO
Block GPU Type	Nvidia
Block Style	Copper-Plexi
Special Price	\$151.99

