

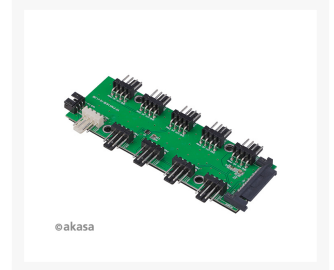

# AKASA FLEXA FP10H

\$14.95

## Product Images

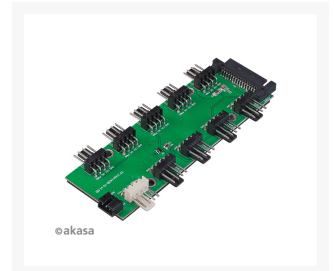
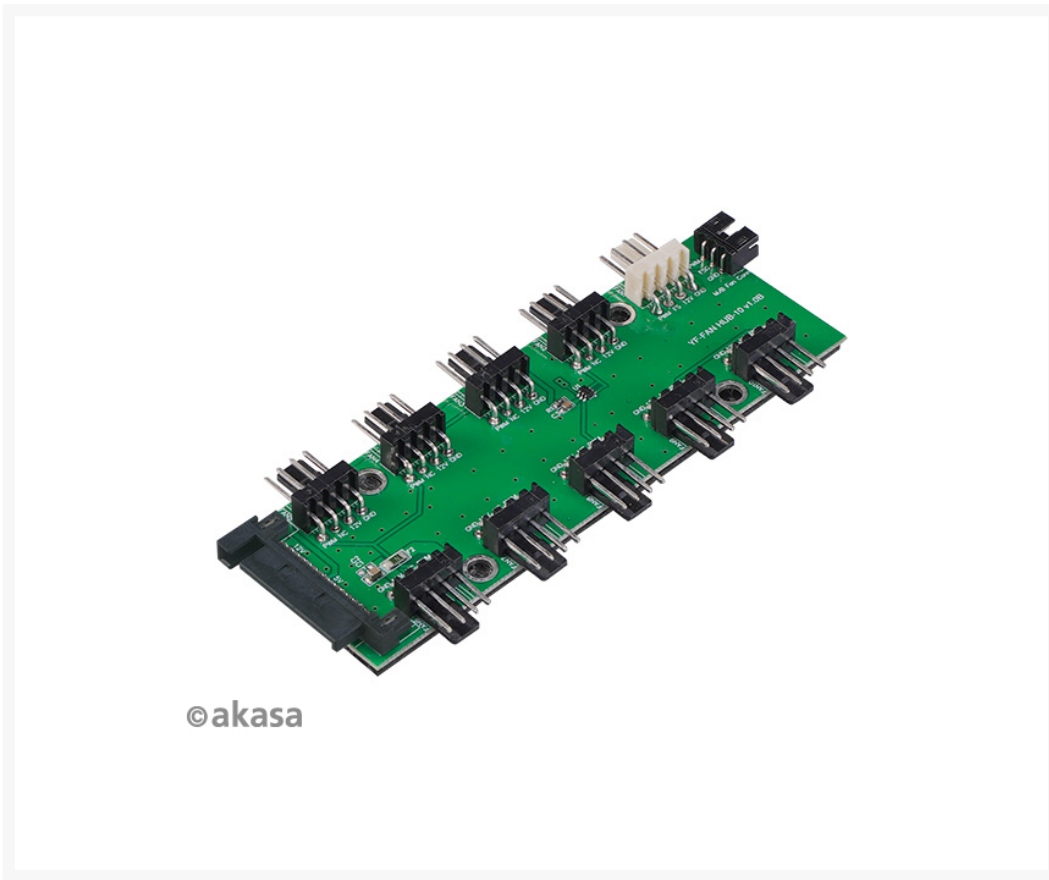

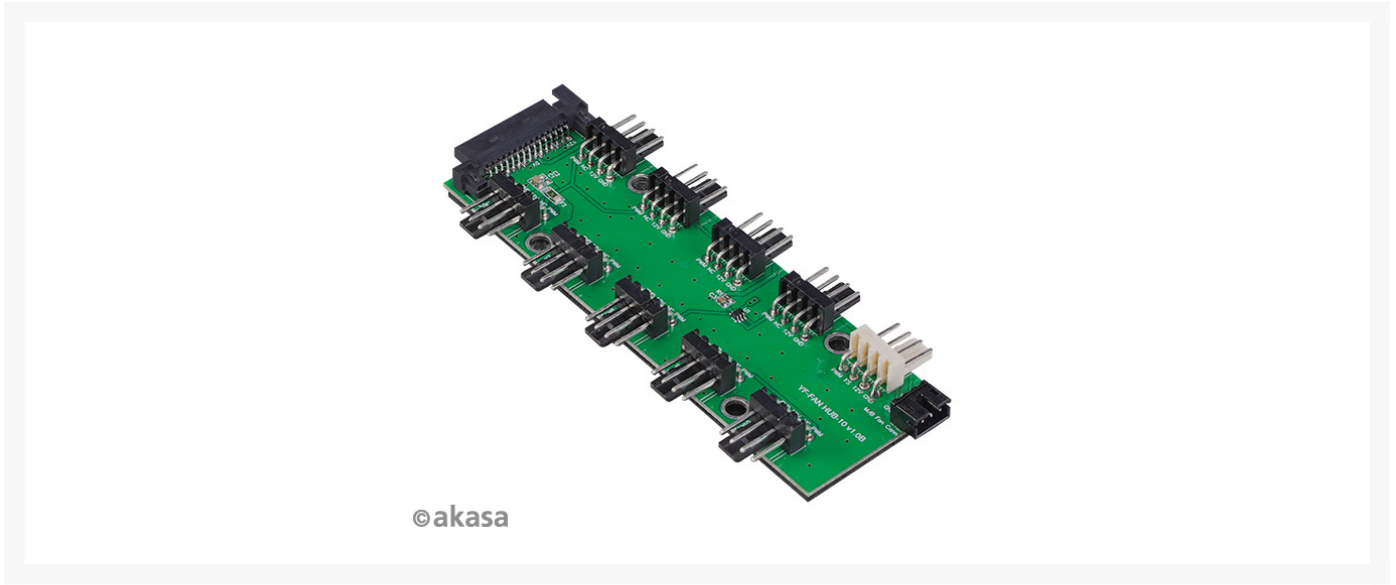

## Short Description

---

Easily expand a single motherboard's PWM header into 10 PWM headers, ensuring quiet and efficient system operation, with reduced cable clutter. Effortless mounting with included strong adhesive tape. Supports up to 0.2A/12V output per channel.

## Description

---

### FLEXA FP10H

Easily expand a single motherboard's PWM header into 10 PWM headers, ensuring quiet and efficient system operation, with reduced cable clutter. Effortless mounting with included strong adhesive tape. Supports up to 0.2A/12V output per channel.

## Features

---

# FLEXA

## FP10H

### 1-To-10 PWM Hub

- Connect up to 10 PWM devices
- Reduced cable clutter
- Easy mounting
- Powered directly from the power supply



Easy mounting  
with included  
adhesive tape



Connect up to  
10 PWM devices



0.2A/12V  
Output  
Per Channel

# Connect Up To 10 PWM Devices

Easily expands a single motherboard's PWM fan header into 10 PWM headers for greater connectivity - supporting up to 0.2A/12V output per channel. Dedicated white-coloured connector for 4-pin PWM device sync.

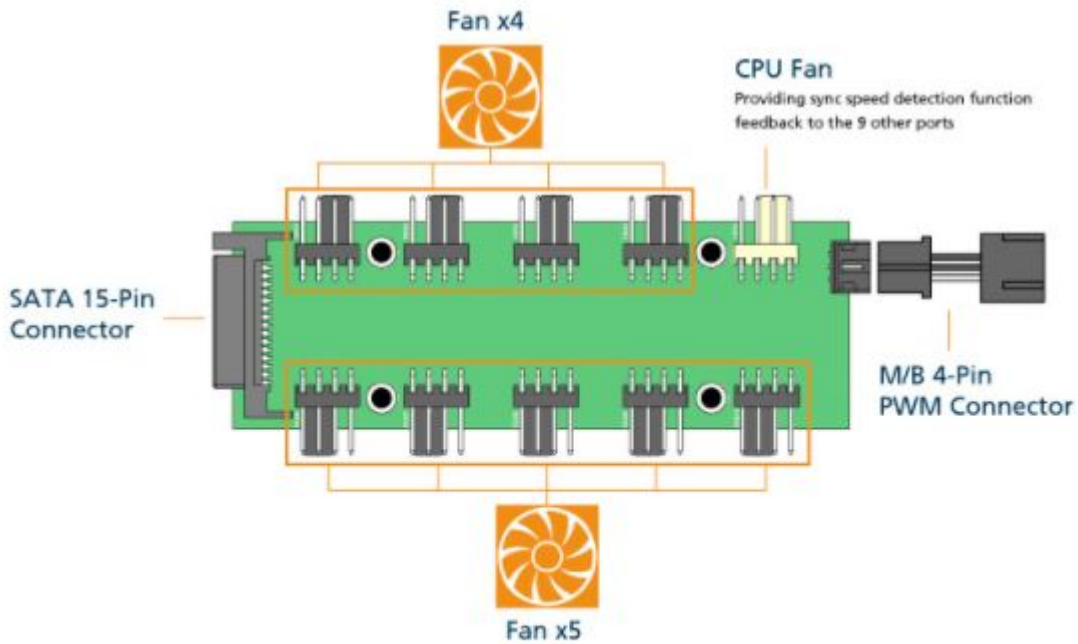

## Reduced Cable Clutter

10 headers in one hub coupled with compact design ensures reduction in cable clutter and saves space in any PC.



# Easy Mounting

Hassle free mounting with included adhesive tape.

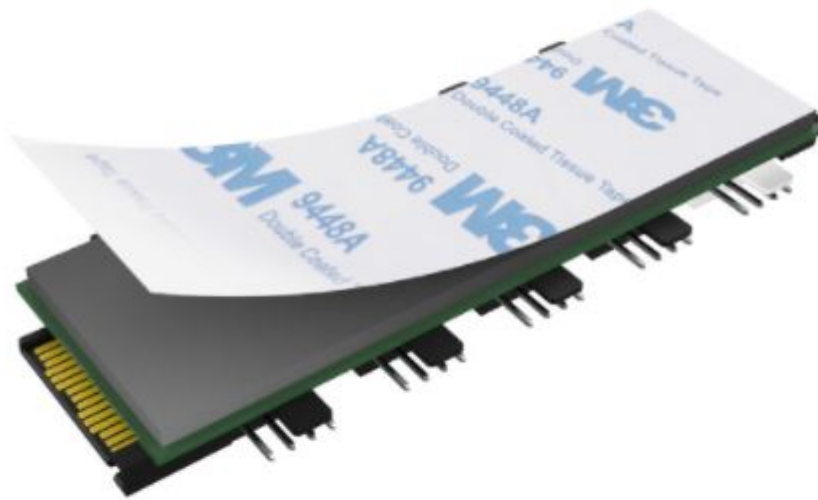

# Powered Directly from the PSU

Connects and powered by a stable SATA connection from the power supply.

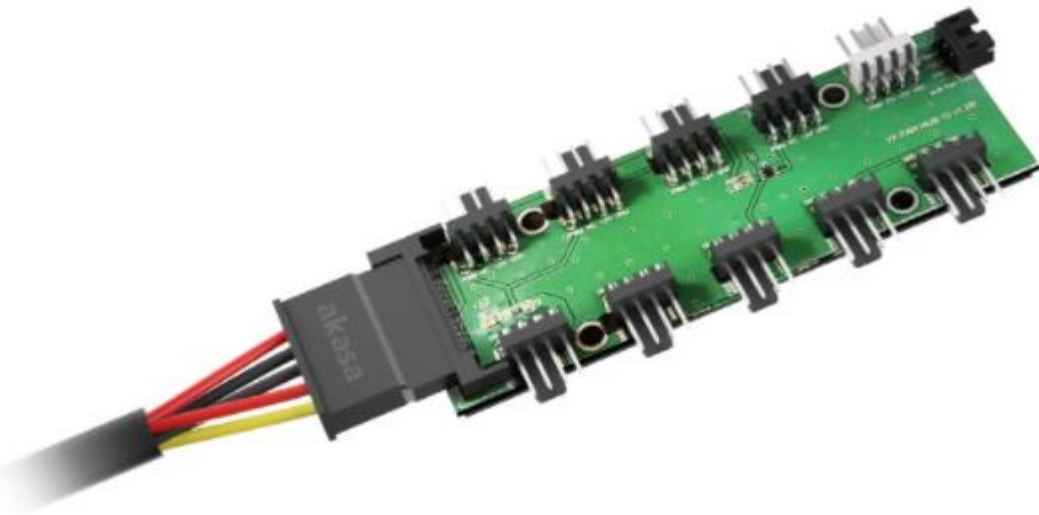

## Specifications

Application	10 PWM headers from single PWM header
Designed For	4-pin PWM Fans
Fan Connector	10x 4-pin PWM
Output Limit	0.2A/12V per channel
Product Code	AK-CBFA09-50BK

## Additional Information

---

Brand	Akasa
SKU	AK-CBFA09-50BK
Weight	0.1000
Color	Black
Fan Accessory Type	PWM Fan Hub
Shape	Rectangle

