

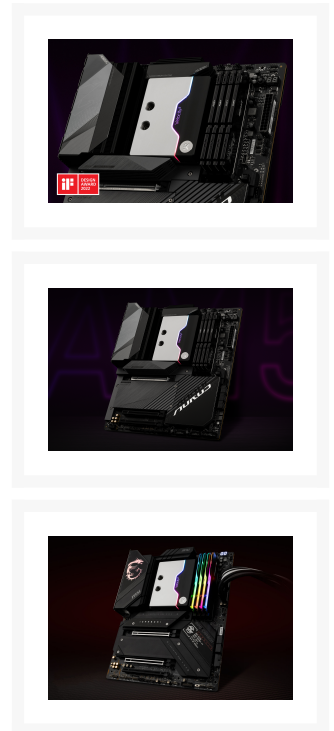

# EK-Quantum Velocity<sup>2</sup> D- RGB - AM5 Nickel + Satin Titanium

\$178.99

## Product Images



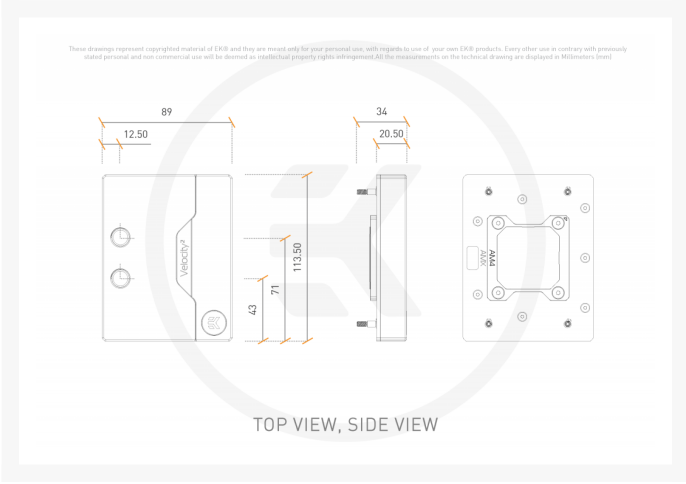
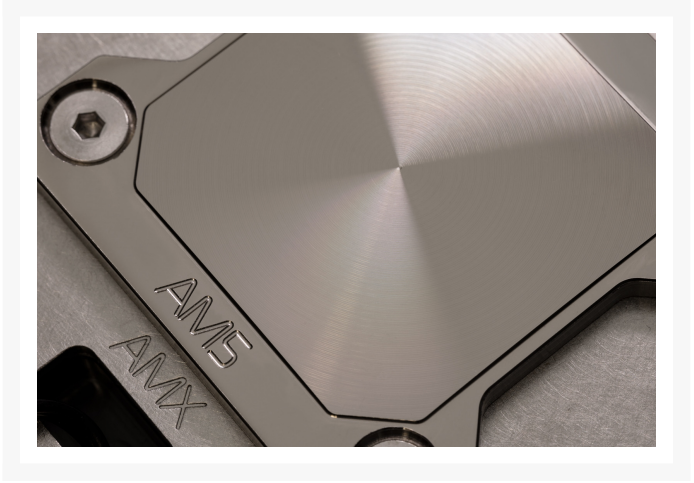
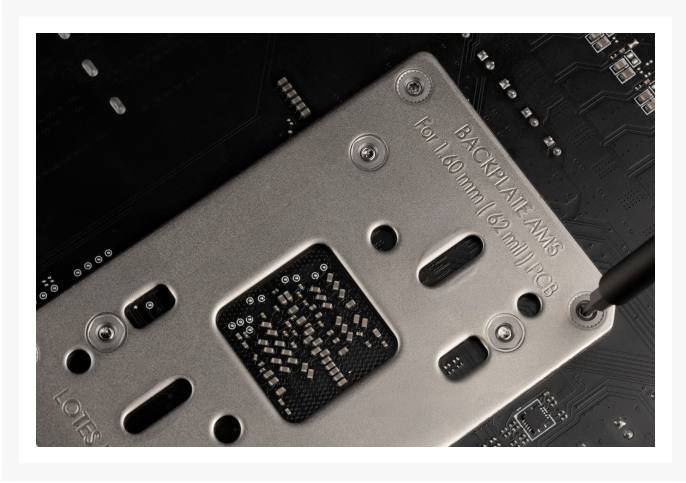
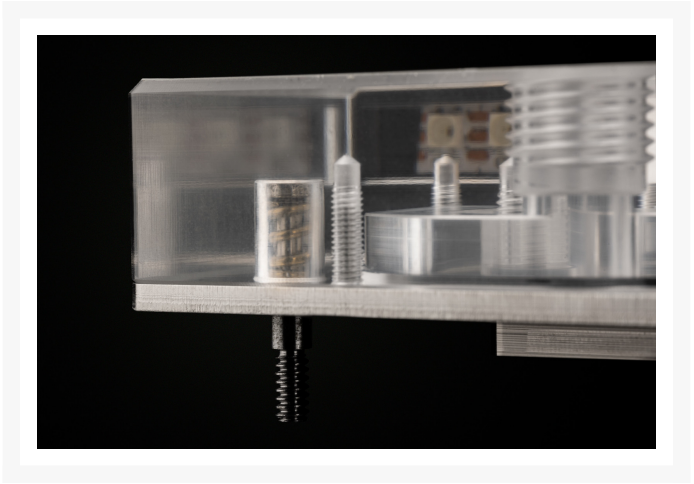
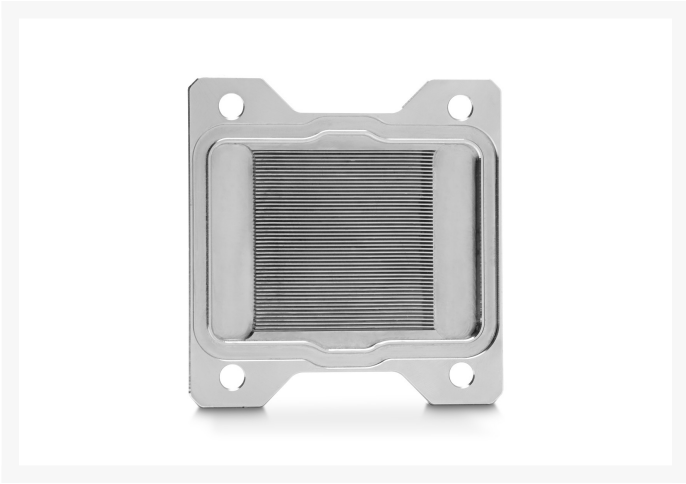

## Short Description

This socket-specific EK-Quantum Velocity<sup>2</sup> water block is engineered specifically for AMD® AM5 Socket and Ryzen 7000-series CPUs.

## Description

---

## Details

# AMD RYZEN 7000 SERIES

This socket-specific EK-Quantum Velocity<sup>2</sup> water block is engineered specifically for AMD® AM5 Socket and Ryzen 7000-series CPUs. It is built upon an award-winning, market-recognized platform that has received the IF Design award, European Hardware Award, CES Innovation award, and several other performance review awards as well. With a revolutionary "clean-front" design, with no visible mounting screws, Velocity<sup>2</sup> water blocks are on the route to outshining their predecessor and taking over the market lead.

The featured motherboards on this product page are:

[GIGABYTE X670E AORUS MASTER](#)

[MSI MPG X670E CARBON WIFI](#)

The EK-Quantum Velocity<sup>2</sup> D-RGB - AM5 Nickel + Satin Titanium is a high-performance premium quality CPU water block for the AMD AM5 socket platform. It features a next-generation cooling engine that is socket-specific, tailored to the IHS and die layout of Ryzen 7000-series CPUs. This CPU water block is EK-Matrix7 compliant and is mounted via the patent-pending EK Exact Mount system.



## Features

---

### Socket Specific Cooling Engine

Embedded in the Velocity<sup>2</sup> is a socket-specific low hydraulic flow restriction and high-performance cooling engine, which is achieved by a combination of mounting pressure and cold plate geometry tailored for the IHS and die layout of the AMD AM5 socket. The lathe-turned cold plate is made with precision to cover the

IHS effectively and put optimal pressure on the die area. Flow is also being directed into areas that need it most with the help of an asymmetric jet plate cutout. The Velocity<sup>2</sup> series water blocks cover the entirety of the socket while conforming to socket guidelines about mounting pressure and socket keep-out zones.



## EK-ExactMount

Because of the integrated, sturdy stock backplate arriving with AM5 motherboards, the patent-pending EK-ExactMount mounting system was re-engineered for an even simpler installation process. The end result is an even easier-to-use and “invisible” mounting mechanism since the entire mounting system is inside the water block, and now it is a true single-piece product. The backplate is factory-mounted on the motherboard, and the spring-loaded Torx screws are integrated into the water block and are screwed by counter-clockwise rotation into the stock backplate of the motherboard.

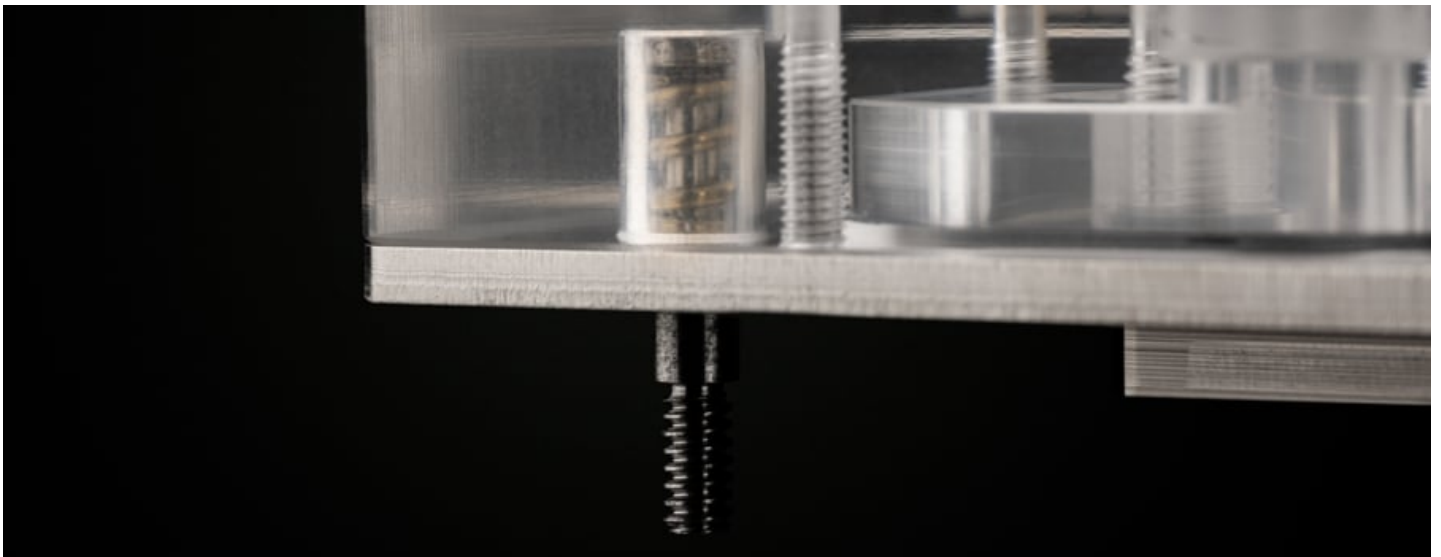

The integrated mounting screws are engineered with a hard-stop design, so once screws reach the end of the thread, the block is perfectly mounted and tensioned. This removes the risks of over-torquing the water block and potentially damaging your motherboard and/or CPU.

## Water Block Material and Manufacturing

The coldplate is manufactured out of the highest-grade 99.99% pure electrolytic copper, machined with precision for the best possible contact and heat transfer which is further nickel-plated. This version of the water block features a nickel-plated cold plate and a CNC-machined brass top with a Satin Silver finish.

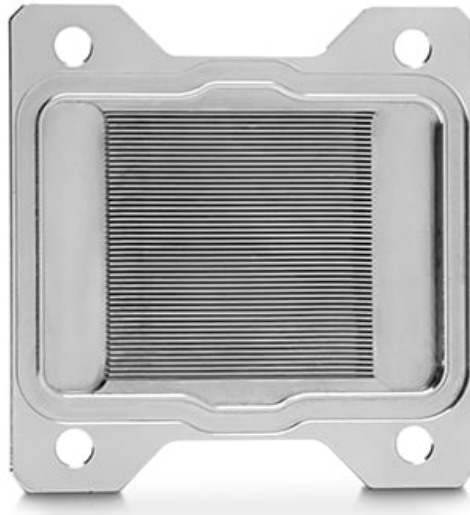

## EK-Matrix7 Compliant

The EK-Quantum Velocity<sup>2</sup> is an [EK-Matrix7](#) compatible product. The EK-Matrix7 is a product raster that is bound to set a new standard. EK is adding a new dimension to PC liquid cooling, where the height of products and the distance between ports are managed by increments of 7mm. This improves product alignment and reduces the time spent planning the loop and bending tubes. Through the meticulous planning of our products, building a liquid-cooled PC becomes easy and fun, just like toy bricks.

## EK-Quantum Velocity<sup>2</sup> D-RGB LED Lighting

This product is compatible with all popular addressable RGB sync technologies from all major motherboard manufacturers. The arrow marking on the 3-pin D-RGB LED connector is to be aligned with the +5V marking on the D-RGB header. A total of 17 addressable RGB LEDs are hidden under the stick-out piece, which acts as a diffuser.

## Winning Prestigious Awards at Great Velocity

We shouldn't forget to mention that our Velocity<sup>2</sup> products have taken home five prestigious awards so far. Their performance, innovative design, and bold approach to creating water cooling solutions ensured this product line gets the recognition it deserves. The awards given to Velocity<sup>2</sup> products include [iF Design](#), [European Hardware Awards](#), [CES 22](#), and others.



## Specifications

---

Technical specifications:

- D-RGB cable length: 50cm
- D-RGB connector: 3-pin 5V digital LED header (Pinout: +5V | Digital | Blocked | Ground)
- Dimensions: (LxHxW) - 89x113,5x34mm

CPU socket compatibility:

- AMD AM5



Enclosed:

- EK-Quantum Velocity<sup>2</sup> CPU water block
- Torx T7 key
- Thermal grease Thermal Grizzly Hydronaut (1g)

Made in Slovenia - Europe!

PLEASE NOTE:

- This product should NOT be installed with any aluminum liquid cooling parts!
- The use of specifically engineered coolants that contain corrosion, scale, and biological inhibitors is mandatory to prevent damage to your nickel-plated water block! EK is offering a selection of such products in the [coolants](#) section.
- The arrow marking on the 3-pin LED connector is to be aligned with the +5V marking on the D-RGB(A-RGB) header.
- A Torx T7 screw bit is a mandatory tool to install the water block (included)
- The mounting screws are engineered with a hard-stop design, once the screw reaches the end of the thread, stop applying more force.

## Additional Info

	Nickel Satin Titanium
	G1/4
	AM5

## Additional Information

---

Brand	EK Waterblocks
SKU	EK-QUANT-VEL2-DRGB-AM5-ST
Weight	2.5000
CPU Series	AM5
Block CPU Type	AMD
Block Style	Nickel-Satin Titanium
Vendor SKU/EAN	3831109861684

